

1

Kit 145389

FORD Explorer Electric, 5-dr SUV, 24-



ISO 11154-E

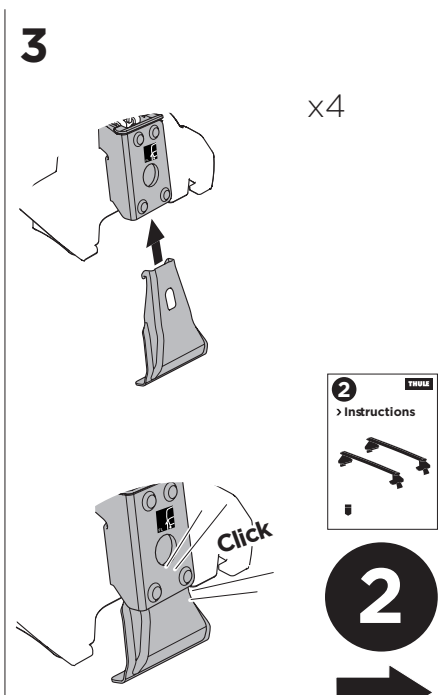
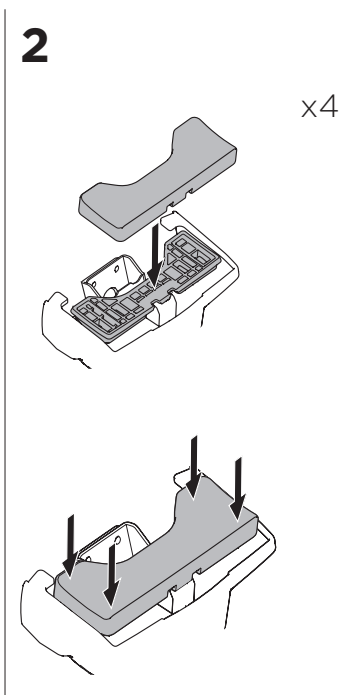
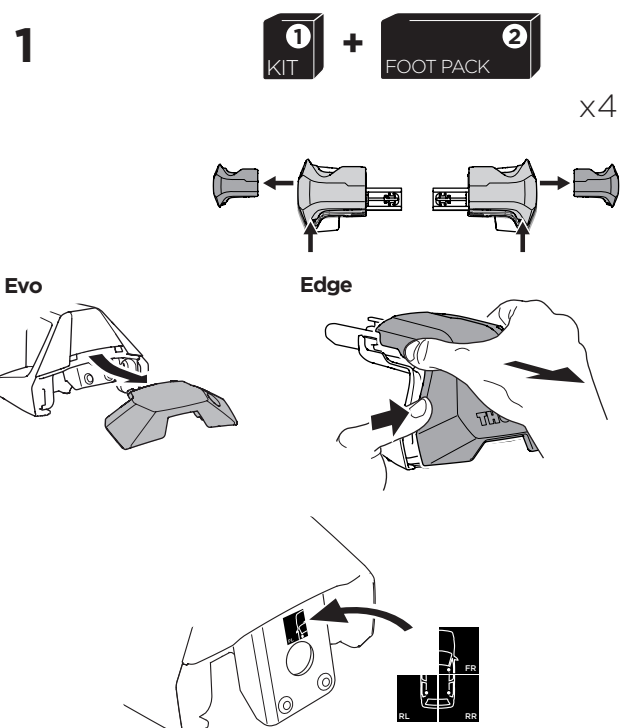
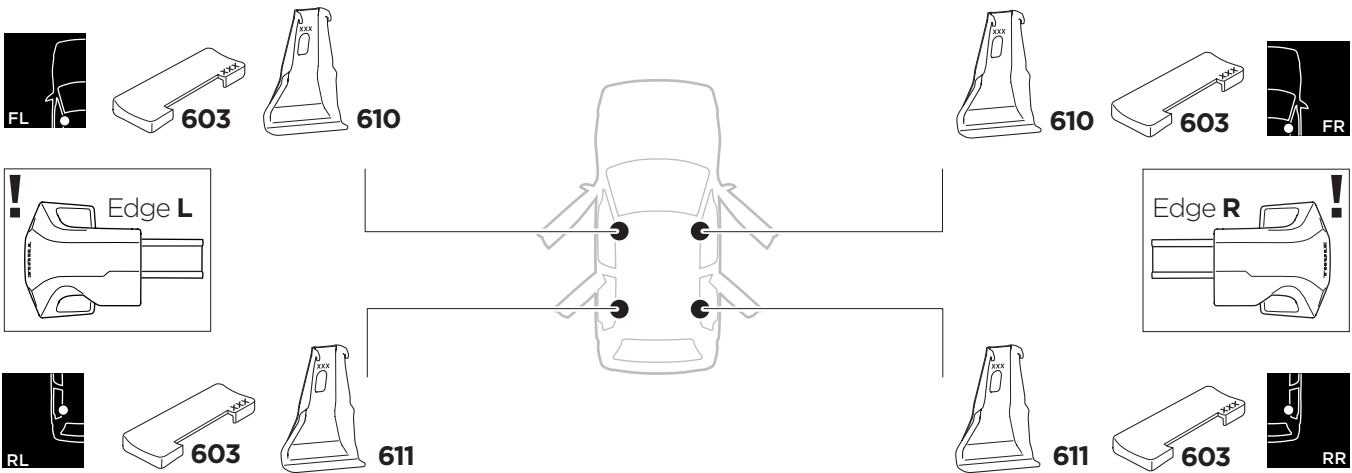
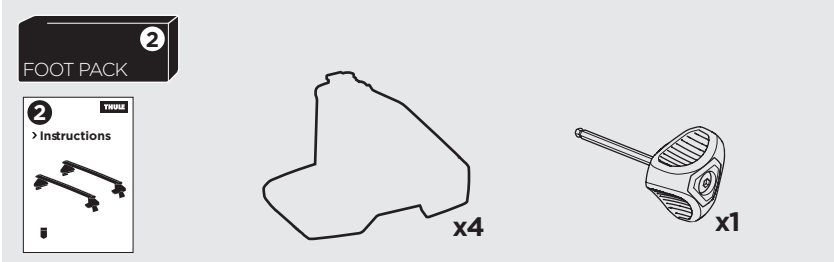
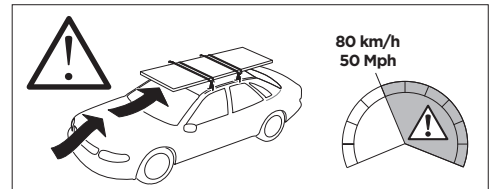
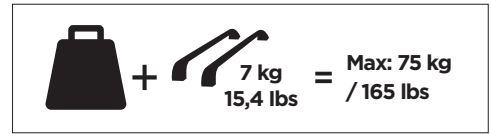
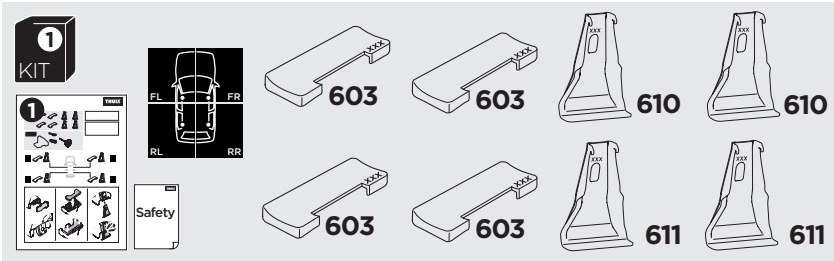

Bring your life
thule.com



THULE WingBar Evo	THULE WingBar Edge	THULE WingBar	THULE SquareBar Evo	Evo X (scale)	Edge X (scale)
FORD Explorer Electric, 5-dr SUV, 24-				41	O
THULE ProBar Evo	THULE SlideBar Evo				X (mm/inch)
FORD Explorer Electric, 5-dr SUV, 24-				1061 mm / 41 ³ / ₄ "	

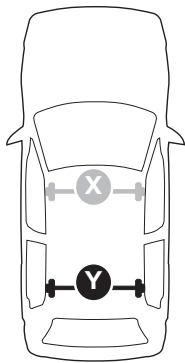

THULE WingBar Evo	THULE WingBar Edge	THULE WingBar	THULE SquareBar Evo	Evo Y (scale)	Edge Y (scale)
FORD Explorer Electric, 5-dr SUV, 24-				38	C
THULE ProBar Evo	THULE SlideBar Evo				Y (mm/inch)
FORD Explorer Electric, 5-dr SUV, 24-				1031 mm / 40 ⁵ / ₈ "	

	W (mm/inch)	Z (mm/inch)
FORD Explorer Electric, 5-dr SUV, 24-	770 mm / 30 ³ / ₈ "	292 mm / 11 ¹ / ₂ "

