

**1**

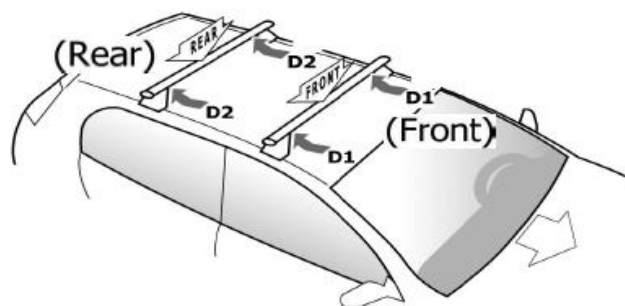

MANUFACTURER	MODEL CAR	DOORS	MODEL YEAR	D1	D2
BMW	X1 (F48)	5	15>19	10,6	9,8
BMW	X3 (F25)	5	10>17	9,4	9,4
FIAT	500 X	5	15>	7,5	6,8
FIAT	Brava	5	95>01	9,5	9,5
FIAT	Marea	4	96>03	9,2	9,2
FIAT	Panda II (169)	5	03>12	13,4	12,7
FORD	C-Max II	5	10>	12,6	10,2
FORD	Edge	5	16>	11,5	11,5
JAGUAR	E-Pace (X540)	5	17>	9,5	11,1
KIA	Sorento (UM)	5	19>	10,7	9,8
KIA	Venga (No tetto in vetro / No glass sunroof)	5	14>	9,0	6,6
LEXUS	ES (XZ10)	4	18>	9,8	8,3
LEXUS	RX (AL20)	5	15>	9,7	9,7
MAZDA	Cx-3	5	15>	15,0	13,7
MAZDA	Cx-5 (KF)	5	17>	10,2	9,4
MERCEDES	X (470)	4	18>	13,8	13,8
NISSAN	Navara / NP300 / Frontier (D23)	4	14>	11,2	11,2
PORSCHE	Cayenne (92A)	5	11>17	14,3	11,7
PORSCHE	Macan (95B)	5	13>	11,1	12,2
RENAULT	Alaskan	4	16>	11,2	11,2
SSANGYONG	Actyon	5	05>10	11,8	11,3
SUZUKI	Vitara / Escudo (LY)	5	15>	10,1	6,5
VOLKSWAGEN	Golf V (1K) Plus	5	03>08	5,5	3,9
VOLKSWAGEN	Touareg II (7P)	5	10>13	3,8	2,1

**2**

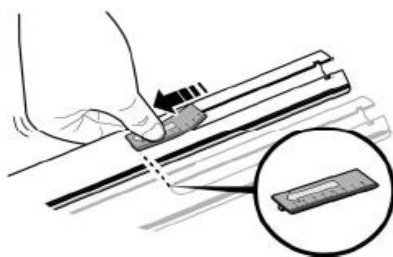
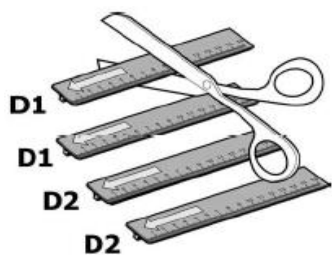
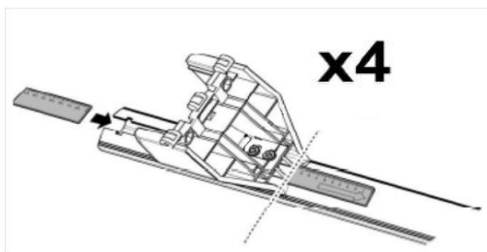
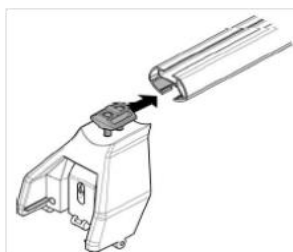

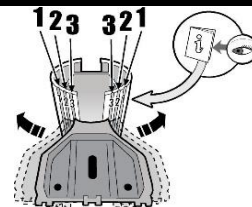
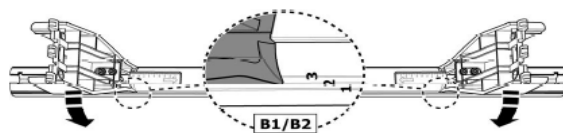
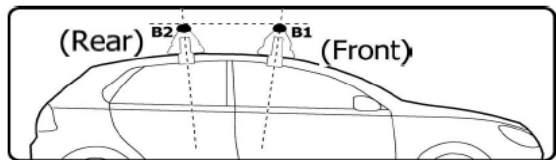

MANUFACTURER	MODEL CAR	DOORS	MODEL YEAR	B1	B2
BMW	X1 (F48)	5	15>19	2	2
BMW	X3 (F25)	5	10>17	1	2
FIAT	500 X	5	15>	1	2
FIAT	Brava	5	95>01	2	2
FIAT	Marea	4	96>03	2	2
FIAT	Panda II (169)	5	03>12	1	2
FORD	C-Max II	5	10>	1	1
FORD	Edge	5	16>	1	2
JAGUAR	E-Pace (X540)	5	17>	2	1
KIA	Sorento (UM)	5	19>	1	2
KIA	Venga (No tetto in vetro / No glass sunroof)	5	14>	1	2
LEXUS	ES (XZ10)	4	18>	1	2
LEXUS	RX (AL20)	5	15>	1	2
MAZDA	Cx-3	5	15>	1	2
MAZDA	Cx-5 (KF)	5	17>	2	2
MERCEDES	X (470)	4	18>	2	2
NISSAN	Navara / NP300 / Frontier (D23)	4	14>	2	2
PORSCHE	Cayenne (92A)	5	11>17	1	2
PORSCHE	Macan (95B)	5	13>	2	1
RENAULT	Alaskan	4	16>	2	2
SSANGYONG	Actyon	5	05>10	1	1
SUZUKI	Vitara / Escudo (LY)	5	15>	2	2
VOLKSWAGEN	Golf V (1K) Plus	5	03>08	1	2
VOLKSWAGEN	Touareg II (7P)	5	10>13	2	2

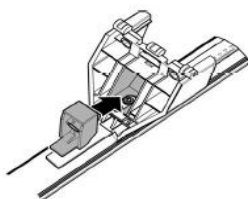
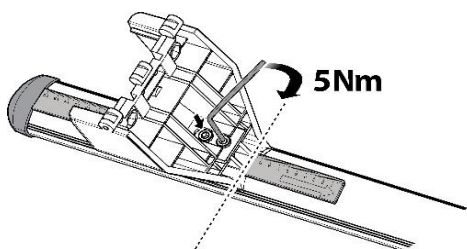

x4

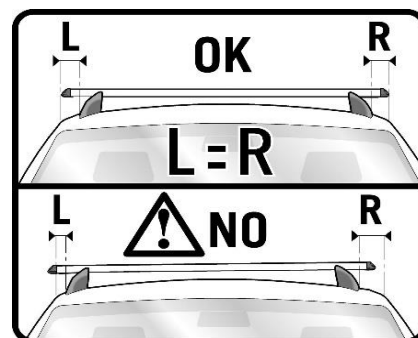
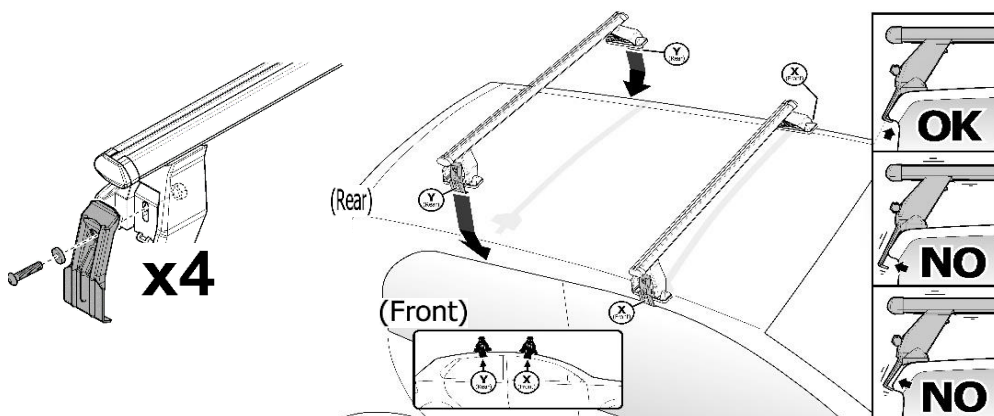
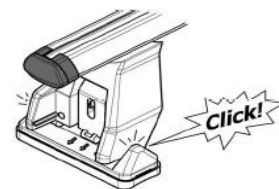

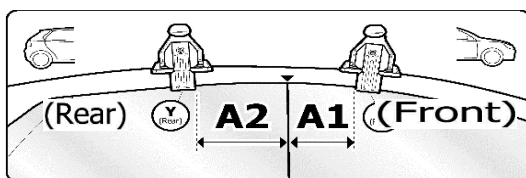

OR

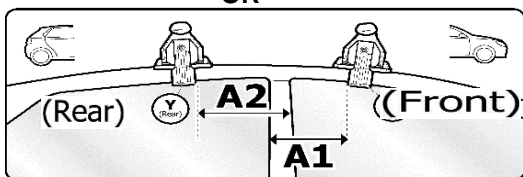

MANUFACTURER	MODEL CAR	DOORS	MODEL YEAR	A1	A2	A1	A2
				cm	cm	in	in
BMW	X1 (F48)	5	15>19	25	47	9,8	18,5
BMW	X3 (F25)	5	10>17	30	43	11,8	16,9
FIAT	500 X	5	15>	38	38	15,0	15,0
FIAT	Brava	5	95>01	X	X	X	X
FIAT	Marea	4	96>03	X	X	X	X
FIAT	Panda II (169)	5	03>12	20	50	7,9	19,7
FORD	C-Max II	5	10>	25	47	9,8	18,5
FORD	Edge	5	16>	25	40	9,8	15,7
JAGUAR	E-Pace (X540)	5	17>	15	41	5,9	16,1
KIA	Sorento (UM)	5	19>	13	56	5,1	22,0
KIA	Venga (No tetto in vetro / No glass sunroof)	5	14>	29	45	11,4	17,7
LEXUS	ES (XZ10)	4	18>	30	37	11,8	14,6
LEXUS	RX (AL20)	5	15>	33	37	13,0	14,6
MAZDA	Cx-3	5	15>	26	43	10,2	16,9
MAZDA	Cx-5 (KF)	5	17>	23	47	9,1	18,5
MERCEDES	X (470)	4	18>	22	47	8,7	18,5
NISSAN	Navara / NP300 / Frontier (D23)	4	14>	23	43	9,1	16,9
PORSCHE	Cayenne (92A)	5	11>17	26	40	10,2	15,7
PORSCHE	Macan (95B)	5	13>	18	46	7,1	18,1
RENAULT	Alaskan	4	16>	23	43	9,1	16,9
SSANGYONG	Actyon	5	05>10	23	45	9,1	17,7
SUZUKI	Vitara / Escudo (LY)	5	15>	33	46	13,0	18,1
VOLKSWAGEN	Golf V (1K) Plus	5	03>08	30	40	11,8	15,7
VOLKSWAGEN	Touareg II (7P)	5	10>13	26	45	10,2	17,7

X = predisposizione originale /original arrangement